

Article number: 604146011037

Description: Timing belt pulley with hub
11 XL 037

Measures

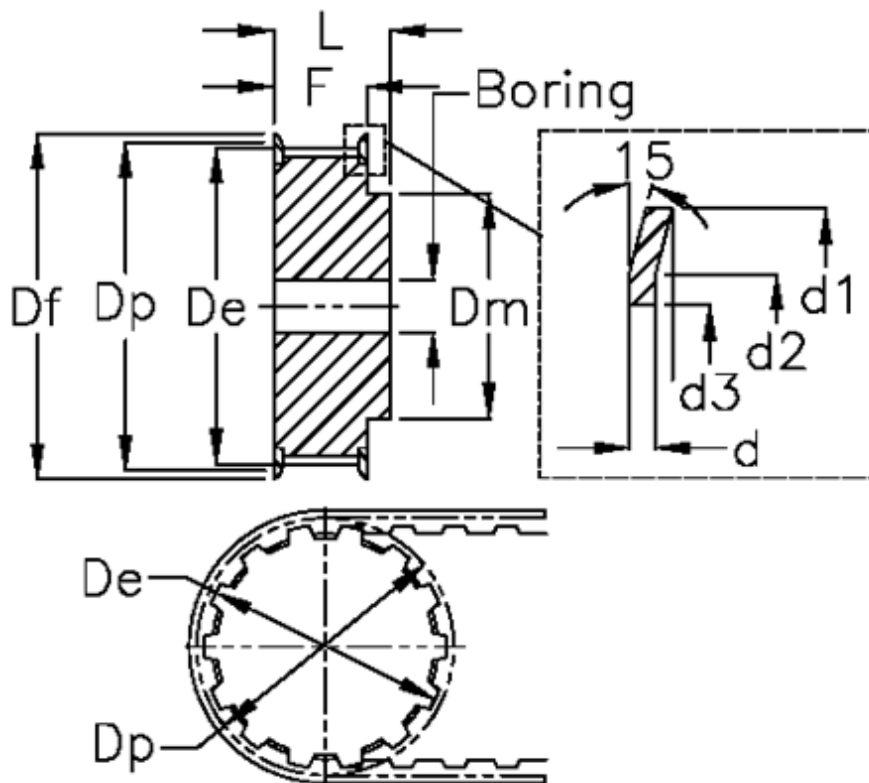

d = 1	F = 14.3	Width = XL 037
d1 = 23	Flange type = F07	
d2 = 18	L = 19.8	
d3 = 12.5	Max bore = 6.4	
De = 17.28	Pitch = 1/5"	
Df = 23	Pre-drilled = 4	
Dm = 11.1	Tooth number = 11	
Dp = 17.79	Weight = 0.02	